



**DBI**  
Deep Breath Intelligence®

# DBI-BreathCollector

















## Instructions For Use

Document No.	017.003.001.en
Document Version	F
Date of Revision	2024-09-19

### Abbreviations

DBI	Deep Breath Intelligence
IVD	In-vitro diagnostic
HCP	Healthcare professional
HR	High resolution
MD	Medical device
MS	Mass spectrometer
SESI	Secondary electrospray ionization

### Explanation of symbols

	<i>In vitro</i> diagnostic medical device		Temperature limit
	Conformité européenne, This product is in conformity with Regulation (EU) 2017/746.		Keep away from direct sunlight
	Legal Manufacturer		Do not reuse
	European Authorised Representative		Do not use if package is damaged
	Consult instructions for use		Keep dry
	Catalog number / article number		Use-by date
	Batch code		Medical device
	Unique Device Identifier		Caution: Federal law restricts this device to sale by or on the order of a physician.

## Contents

<b>1</b>	<b>Overview</b>	<b>4</b>
1.1	Intended Purpose.....	4
1.2	Product Description.....	4
1.3	Intended User.....	5
1.4	Patient Population.....	5
1.5	Scope .....	5
1.6	Precautions .....	5
<b>2</b>	<b>Instructions for HCP</b>	<b>6</b>
2.1	Check Contents .....	6
2.2	Open Packaging of DBI-BreathCollector Bag.....	6
2.3	Identify the Patient.....	7
2.4	Instruct the Patient.....	7
2.5	Open Sealing Cap.....	8
2.6	Unpack Mouthpiece .....	8
2.7	Attach Mouthpiece (or Mask).....	9
2.8	Give DBI-BreathCollector to Patient.....	9
2.9	Breath Sampling .....	10
2.10	Return DBI-BreathCollector to HCP .....	10
2.11	Place Sealing Cap.....	11
2.12	Prepare DBI-BreathCollector for Shipping .....	12
2.13	Send DBI-BreathCollector to Analysis Laboratory .....	13
<b>3</b>	<b>Instructions for Laboratory Technician</b>	<b>14</b>
3.1	Availability of SESI-Adapter .....	14
3.2	Delivery of DBI-BreathCollector.....	14
3.3	Unpack DBI-BreathCollector .....	14
3.4	Register Sample.....	15
3.5	Bring Sample to Analysis Device .....	15
3.6	Connect Sample to Analysis Device.....	15
3.7	Inject Sample.....	16
3.8	Disposal .....	17
<b>4</b>	<b>Supply &amp; Support</b>	<b>18</b>
<b>5</b>	<b>Technical Specifications</b>	<b>19</b>
5.1	Material.....	19
5.2	Performance .....	19
<b>6</b>	<b>Appendix</b>	<b>19</b>
6.1	Breath injection instructions for SESI-HRMS .....	19
6.2	Quick Guide - Instructions for Use .....	20

## 1 Overview

### 1.1 Intended Purpose

The DBI-BreathCollector breath bag is an inflatable, non-sterile, single use specimen collection device intended for use by persons instructed by an HCP that collects and stores actively exhaled breath gases. The breath gases collected with the bag of the device are intended for subsequent analysis of their composition by an analytical device (e.g. SESI-HRMS).

The SESI-Adapter of the DBI-BreathCollector is intended to connect the DBI-BreathCollector breath bag to an analytical device to inject breath specimen from the breath bag into the analytical device for subsequent analysis. The adapter is intended to be used by laboratory personnel.

### 1.2 Product Description

The DBI-BreathCollector (DBI-1001-C-07) comes in different packaging configurations (see sales item list in Section 4 Supply & Support). It is meant for single use. The breath bag (1) is the essential part of the device. A mouthpiece (6) is attached to the bag spout (2) containing a check valve (3) that prevents the collected breath gases from escaping. Instead of the mouthpiece, a mask (22 mm tapered connection complying with ISO 5356) and possibly appropriate adapters can be attached to the breath bag.

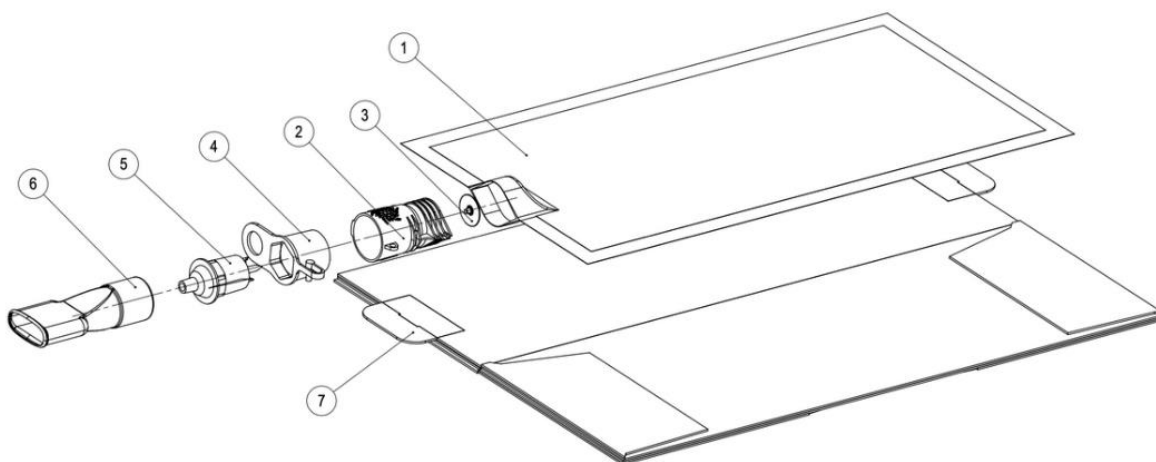

Picture 1: DBI-C-1001-07 DBI-BreathCollector Bag (IVD) consisting of (1) Bag, (2) Valve body, (3) check (umbrella) valve, (4) Sealing cap with (5) SESI-Adapter (IVD), (6) Mouthpiece (MD bought from Intersurgical) and (7) Shipper box

The patient will fill the bag with their breath under the supervision of an HCP. Once the breath sample is collected, the mouthpiece is disconnected and disposed. The system is then closed airtight with the sealing cap (4). The airtight system is then sent to the analysis laboratory in a shipping box (7). To open and connect the breath bag to the analysis device, a SESI-Adapter (5) has to be used which punctures the sealing cap and opens the check valve allowing the breath sample to be injected into the analysis device.





The collected breath gases will be used for a qualitative analysis of exhaled drug metabolites and other components in the breath gases.

### Notes



Any serious incident that has occurred in relation to the device shall be reported to the manufacturer and the competent authority of the Member State in which the user and/or the patient is established.

### Notes

	Mask and possibly appropriate adapters are not part of the kit and shall be ordered separately.
	Mouthpieces are only provided in the DBI-BreathCollector Supreme Kit-40 and shall be ordered separately as needed.
	SESI-Adapters for the analysis device are not included in the kit but are sent directly to the analysis laboratory.
	A breath release mechanism is available for laboratories for controlled breath injection into the analysis device.

### 1.3 Intended User

The **primary user** is a healthcare professional, who unpacks and prepares the sample collection device and instructs the patient according to the instructions for use provided to exhale and fill the device correctly. After this step, the primary user closes the filled collection device properly.

The **secondary user** is a patient who fills the collection device with breath gases, with the assistance of the HCP.

The **tertiary user** is trained clinical laboratory personnel, who inject the sample from the collection device into an analysis device and discard the device after use.

### 1.4 Patient Population

The DBI-BreathCollector is designed to be used by the following patient groups:

**Primary target group:** All patients who can provide their breath sample themselves under the supervision of an HCP. Patients of the primary target group shall be able to provide at least 1L of breath.







**Secondary target group:** All others who cannot provide their breath sample themselves (e.g., children <4 years and patients with impaired function) can provide their breath sample via a mask and possibly appropriate adapters that can be attached to the spout. Masks and possibly appropriate adapters are not part of the kit and shall be obtained separately.

### 1.5 Scope

In scope of this document is the DBI-BreathCollector. Out of scope of this document are third party measurement devices used for the analysis of the sample, such as:

- HRMS Orbitrap Exactive from Thermo Fisher Scientific (USA)
- Super-SESI from Fossiliontech (Spain)
- Specific tests for the analysis of the collected breath sample, such as DBI-EPIbreath®
- All other measuring devices

### 1.6 Precautions

	DBI-BreathCollector is a single-use device. No parts shall be used more than once.
	DBI-BreathCollector shall only be used under the supervision of an HCP in a medical environment.
	DBI-BreathCollector is an IVD medical product and shall only be used with validated tests for the analysis of the breath sample.
	The patient shall avoid eating, drinking (except water), smoking as well as use of cosmetics at least 1 h before sampling for best quality of the data.
	DBI-BreathCollector shall not be used immediately after cleaning and/or the use of solvents. For best quality of the data wait at least 1 h or, best, overnight before sampling.
	The results of the DBI-BreathCollector shall not be used if the time between sampling and analysis exceeds the recommended 144 hours.

## 2 Instructions for HCP

### 2.1 Check Contents

For a clinical test, the following components should be available at the healthcare facility.

- **DBI-BreathCollector** Breath Bag
- **DBI-BreathCollector** Mouthpiece (only incl. in DBI-BreathCollector Supreme Kit-40)
- **DBI-BreathCollector** Shipping Box

Check the components for defects. If anything is damaged, use a new component to guarantee the quality of the data. Please report broken devices to the legal manufacturer (4 Supply & Support).

#### Notes



Mask and possibly appropriate adapters are not part of the system and shall be ordered separately.

### 2.2 Open Packaging of DBI-BreathCollector Bag

Put on gloves to avoid contamination of the DBI-BreathCollector bag before opening the wrapping.

Open the wrapping carefully using scissors without damaging any parts of the kit.

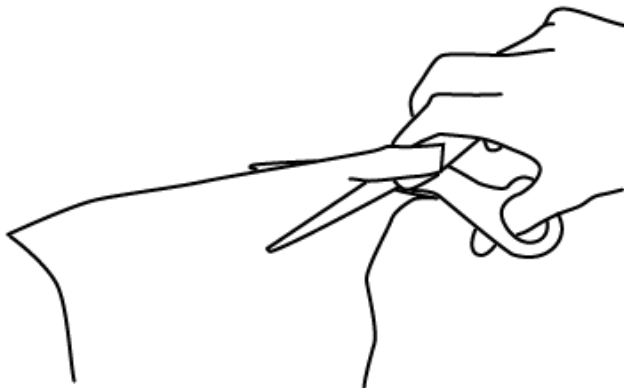

Visually inspect all components for any defects. If anything is damaged, use a new component to guarantee the quality of the data.

#### Notes



Open any sealed packages in a clean environment to avoid contamination.

### 2.3 Identify the Patient

Check that the laboratory form matches the patient's identity to ensure accurate identification.

Attach the laboratory form to the DBI-BreathCollector in the accordingly labelled fields.

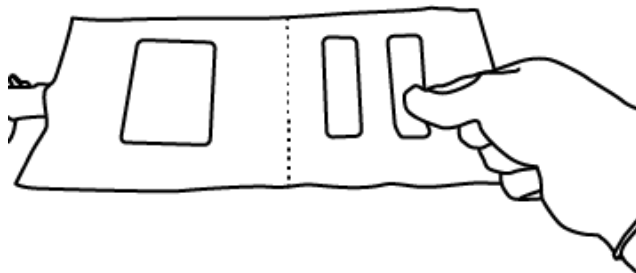

Fill in the required information on the laboratory form, including **sample ID, date and time of sampling, recipient**.

Additional information may be required on the laboratory form depending on the type of test performed on the breath sample, such as:



- Eating and drinking 1h prior to sampling (except water)
- (Concomitant) Medication
- Smoking
- Use of cosmetics

### 2.4 Instruct the Patient

Explain the following procedure to the patient. You can also demonstrate how to hold and exhale into the device with the wrapped mouthpiece.

1. You will attach the mouthpiece to the bag.
2. The patient shall take the bag into their hands, gripping it safely but not too tight.
3. While holding the bag with two hands, the patient shall inhale and then exhale the air through the mouth into the bag by gently covering the mouthpiece with their lips. They shall inflate the collection bag like a balloon.
4. The patient shall continue to exhale into the device until they feel the resistance of the bag, showing that the bag is filled sufficiently.
5. The patient shall carefully return the bag to the HCP.

### Notes

	Do not squeeze the bag once it is full to avoid leakage.
	Do not bite down on the mouthpiece as this could cause damage to the mouthpiece.
	Be mindful of contact with the opening of the device to avoid contamination.

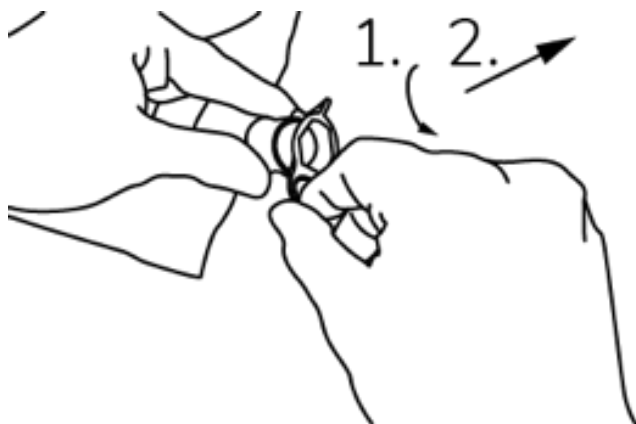

### 2.5 Open Sealing Cap

Open the sealing cap by first twisting and then pulling it out straight from the spout.



The sealing cap is connected to the spout and can remain hanging while sampling.

#### Notes

	Wear gloves when opening the sealing cap.
	Be mindful of contact with the hanging sealing cap to avoid contamination.



### 2.6 Unpack Mouthpiece

Unpack the mouthpiece only after you have instructed the patient, and the patient is ready for sampling by tearing open the packaging.

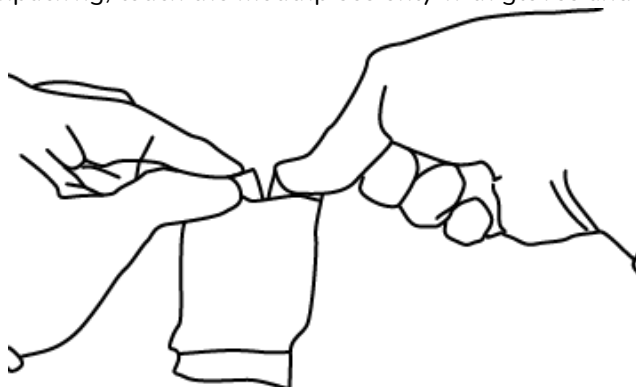
After unpacking, touch the mouthpiece only with gloves and with the wrapping to avoid contamination.



#### Notes

	Wear gloves, when unpacking the mouthpiece.
	Be mindful of contact with the mouthpiece to avoid contamination.
	The mouthpiece is an individually wrapped, sterile product which is co-packed in the DBI-BreathCollector Supreme Kit-40 and available separately (see chapter 4 Supply & Support).



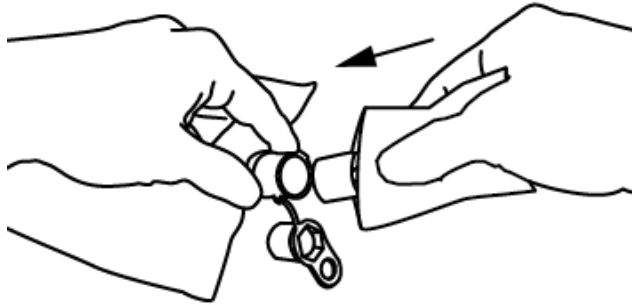

### 2.7 Attach Mouthpiece (or Mask)

Attach the mouthpiece (or mask) to the spout of the collection bag like a plug, **keeping the wrapping on**.



The DBI-BreathCollector is now ready for sampling.



#### Notes

	Wear gloves when attaching the mouthpiece (or mask).
	Do not use excessive force to attach the mouthpiece to the spout to avoid damage of the device.

### 2.8 Give DBI-BreathCollector to Patient

Hand the DBI-BreathCollector over to the patient when they are ready.

#### Notes

	Wear gloves to avoid contamination when handing over the device.
	Be careful when handling the DBI-BreathCollector over to the patient and make sure the patient has sufficiently gripped the bag before releasing it.

## 2.9 Breath Sampling

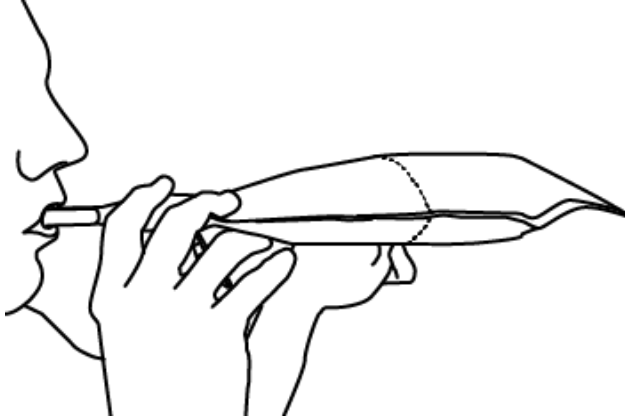

The patient shall hold the DBI-BreathCollector in both hands.

The patient shall take a deep breath, cover the mouthpiece with their lips and inflate the DBI-BreathCollector as if it were a balloon.



The patient shall continue to exhale into the bag until they feel the resistance of the bag. Supervise the patient during the sampling process and provide assistance, whenever necessary. They shall take several breaths, if needed.



### Notes

	If the patient practices a mock exhale (without inflating the bag), they shall wait for about 1 minute before providing their actual breath sample.
	If the patient is unable to perform the sampling for any reason, stop immediately.

## 2.10 Return DBI-BreathCollector to HCP

Gently take the DBI-BreathCollector from the patient.

### Notes

	Do not squeeze the bag once it is full to avoid leakage.
	Wear gloves to avoid contamination.
	Handle the device with care and be mindful of contact to the opening to avoid contamination.

### 2.11 Place Sealing Cap

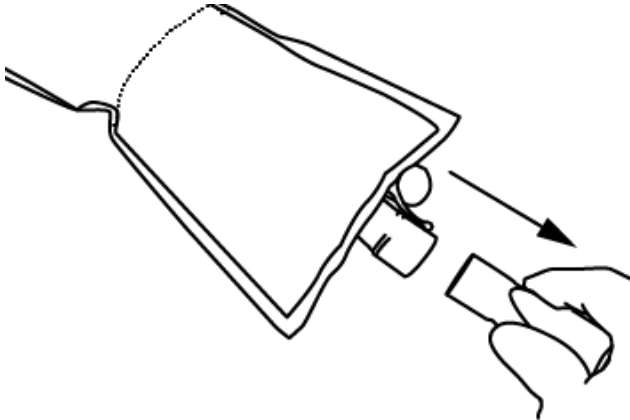

Remove the mouthpiece.

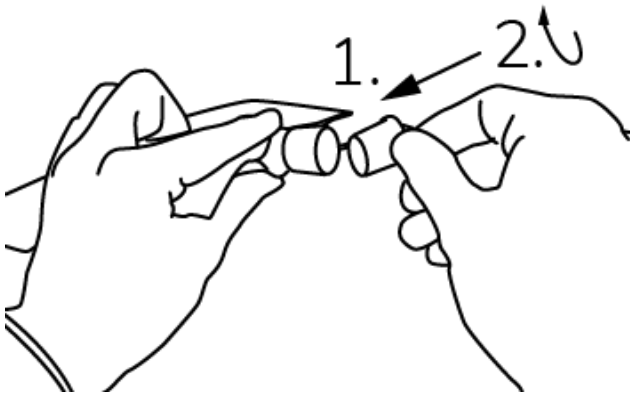

Place the sealing cap back on the spout to **tightly close the breath bag** (push, then turn to snap). This action should be performed within one minute of the patient providing the breath sample.



#### Notes

	Wear gloves to avoid contamination.
	Discard the mouthpiece according to local guidelines.
	Do not use excessive force when placing the sealing cap.

### 2.12 Prepare DBI-BreathCollector for Shipping

Add the **sender and recipient information** on the shipping box.

Fold the shipping box according to the instructions.

1. Unfold the box by opening the sidewalls

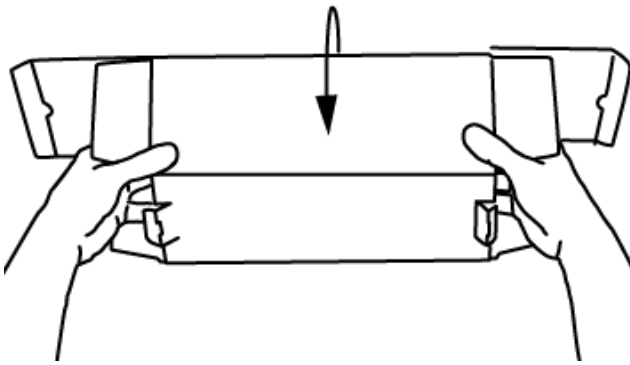

2. Slide the walls to create a box.

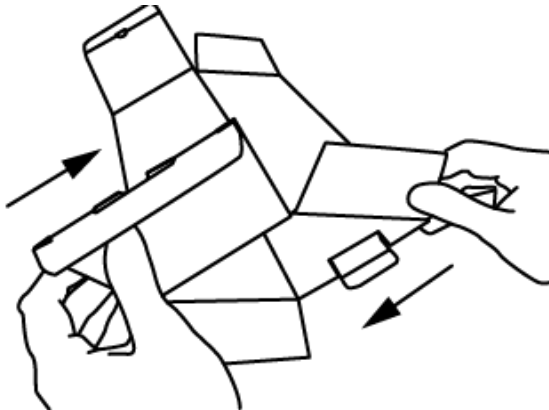

3. Close one side of the shipping box by folding the sidewall (1) and mount with the edge (2).

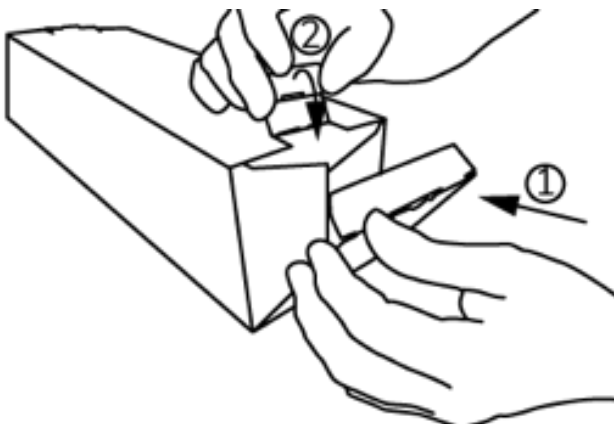

4. Place the full DBI-BreathCollector into the shipping box.

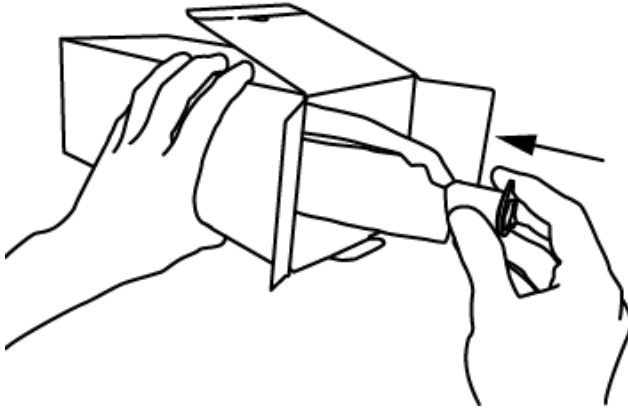

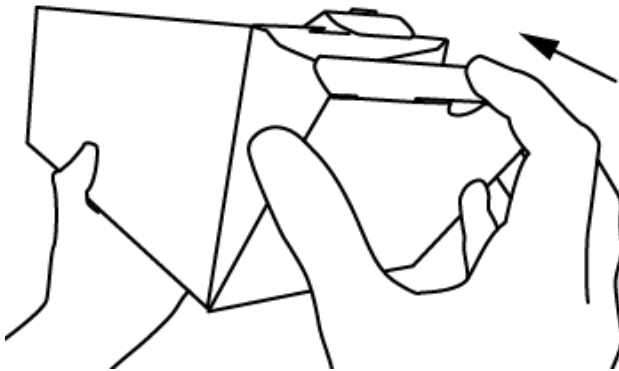

5. Close the shipping box. The DBI-BreathCollector is ready for shipment.



The DBI-BreathCollector should be stored at room temperature until it is picked up by the laboratory courier.

Ensure timely pick up of the DBI-BreathCollector. The analysis shall be performed within 144h after sampling.



### Notes

	Wear gloves to avoid contamination.
	Do not use excessive force when placing the DBI-BreathCollector into the shipping box.

### 2.13 Send DBI-BreathCollector to Analysis Laboratory

The courier will pick up the sample and transfer it into an analysis laboratory.

### Notes

	Store and transport at 4-35°C.
	Do not expose the device to direct sunlight.
	Keep dry.

### 3 Instructions for Laboratory Technician



#### 3.1 Availability of SESI-Adapter

To correctly extract the sample from the breath bag, a SESI-Adapter is needed. The laboratory can order these directly from the legal manufacturer (4 Supply & Support) and is responsible for having an adapter at hand for analysis. In general adapters with a diameter of 22M are necessary to connect the breath bag with an analytical device.

#### 3.2 Delivery of DBI-BreathCollector

The DBI-BreathCollector is delivered to the laboratory and distributed to the appropriate department for analysis.

#### Notes

	Store and transport at 4-35°C.
	Do not expose the device to direct sunlight.
	Keep dry.

#### 3.3 Unpack DBI-BreathCollector

Put on gloves to avoid contamination and unpack the DBI-BreathCollector.

Check that:

- The breath bag is intact (no visible damage).
- The elapsed time from sampling the breath specimen does not exceed the allowed 144h.

If any of the checks are outside of the allowed range, the sampling should be repeated as data quality cannot be assured.



#### Notes

	Wear gloves to avoid contamination.
---	-------------------------------------

### 3.4 Register Sample



Register the sample in the laboratory information system.

Check that the patient data on the bag matches the information in the laboratory information system.

### 3.5 Bring Sample to Analysis Device

Bring the sample to the analysis device.

#### Notes

	Wear gloves to avoid contamination.
	Handle the sample with care to avoid dropping, damage or contamination.

### 3.6 Connect Sample to Analysis Device

Put on gloves to avoid contamination of the adapter before opening the wrapping.

Open the wrapping of the single-use adapter.

First connect the appropriate end of the adapter to the analysis device.

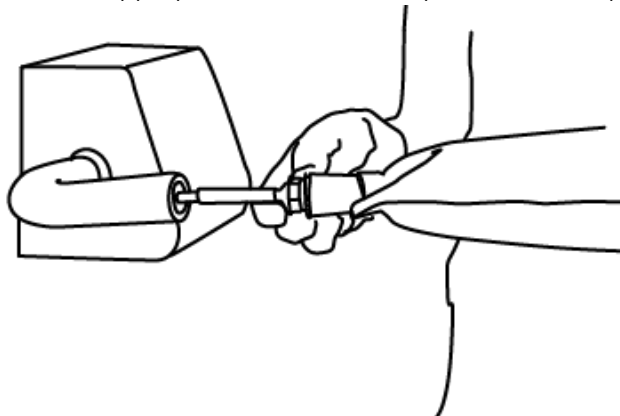

**Do not remove the sealing cap!**

Then push the other end of the adapter into the sealing cap, using both hands, until a tight fit is achieved.

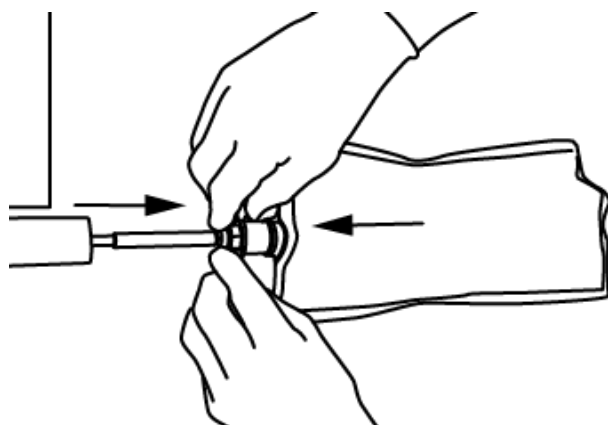

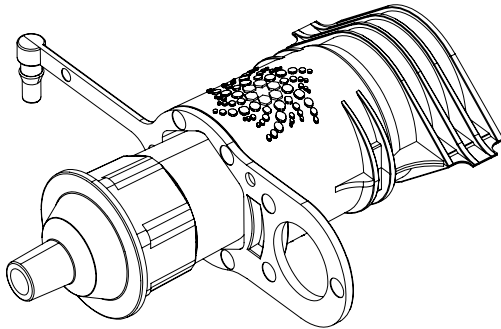

Make sure to align the hexagonal shape of the adapter with that of the sealing cap.



The adapter pierces the sealing cap and opens the one-way valve, allowing the breath sample to be released and analyzed. Sometimes a small (1 mm) gap may remain between the adapter and the breath bag, even though the sealing cap is fully pierced, allowing the sample to be injected.

### Notes

	Wear gloves to avoid contamination.
	Discard the single-use adapter after each sample injection.

### 3.7 Inject Sample

Inject the sample into the analysis device by pressing on the bag with both hands. It is normal to feel quite some resistance of the bag.

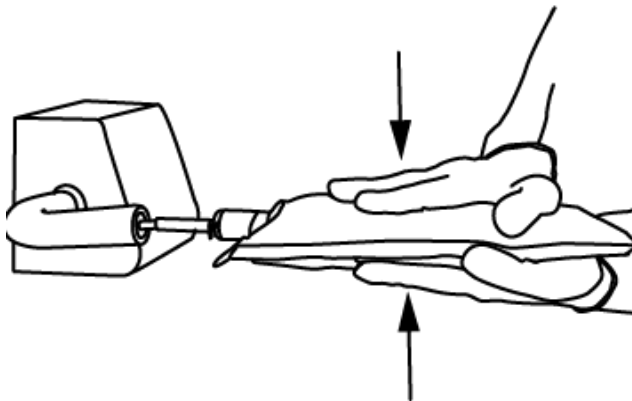



Depending on the analysis device this may require you to inject 50% of the sample and switch to a different setting on the analysis device. Fold the bag at the 50% mark.

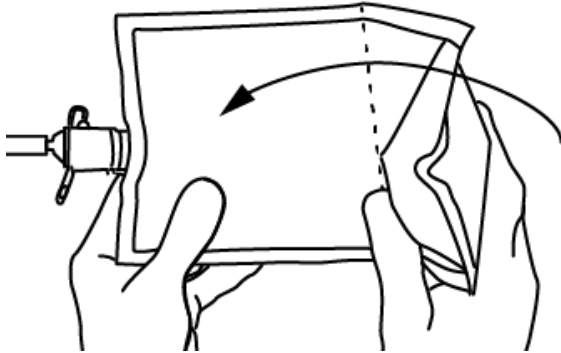

Inject the remaining 50% of the sample.

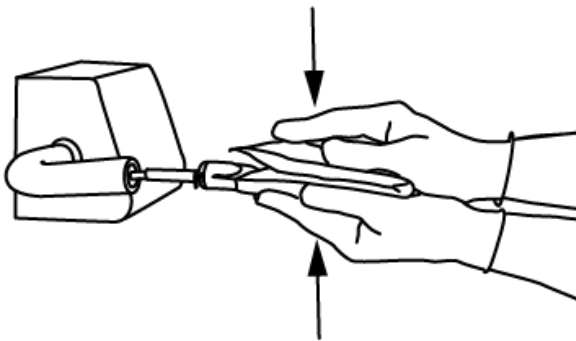

Carefully remove the sample bag from the analysis device.

### 3.8 Disposal

Dispose of this product in accordance with applicable local regulations.

#### Notes



All components are for single use only and shall be discarded after use. Do not clean and reuse them to avoid contamination and assure the quality of the data.

### 4 Supply & Support

The **DBI-BreathCollectors** can be ordered in the following system configurations at Deep Breath Intelligence AG (contact details below).

Name	DBI-BreathCollector SUPREME Kit-40	DBI-BreathCollector STARTER Kit-10	DBI-BreathCollector SESI-Adapter-10
REF	DBI-C-1001-01	DBI-C-1001-03	DBI-C-1001-02
Contains	40 Breath bags 40 Shipping boxes 40 Mouthpieces	10 Breath bags 10 Shipping boxes	10 SESI-Adapters
Consumer	HCPs	HCPs	Laboratories
UDI	7640255020786	7640255020809	7640255020847
Marking	CE	CE	CE

For Support or product related questions, please contact Deep Breath Intelligence AG (see details below).  
 To report any damage or malfunction of the device or its parts please contact the legal manufacturer. or EC REP.

#### Distributed by

Deep Breath Intelligence AG  
 Suurstoffi 29  
 CH – 6343 Rotkreuz  
 Email: [info@dbi.ch](mailto:info@dbi.ch)  
<https://dbi.ch/en/contact>



Effectum Medical AG  
 Kirchgasse 11  
 CH-4600 Olten  
 Email: [support@effectummedical.com](mailto:support@effectummedical.com)



Emergo Europe  
 Westervoortsedijk 60  
 NL-6827 AT Arnhem

The **mouthpieces** (REF: 1930000, Straight mouthpiece, 22M, qty 40) for the DBI-BreathCollector can be ordered directly at the suppliers below.

For Europe:                   **Intersurgical**  
 Siegburger Str.39  
 D-53757 Sankt Augustin  
 Phone: +49 2241 25690  
 Email: [service@intersurgical.de](mailto:service@intersurgical.de)

For Switzerland:           **MK-MED Medizintechnik AG**  
 Industriezone Basper 33  
 CH-3942 Raron  
 Phone: +41 27 948 10 00  
 Email: [info@mk-med.ch](mailto:info@mk-med.ch)

## 5 Technical Specifications

### 5.1 Material

The device and its packaging are made from synthetic materials: **Polyester, Aluminium, Polyethylen**. If any user has known allergies to one of these materials, we advise against using the device. Should you experience an allergic reaction causally associated with the use of the DBI-BreathCollector, please seek medical attention promptly.

### 5.2 Performance

The performance of the DBI-BreathCollector is crucial for its efficacy in capturing breath samples accurately and reliably.

The sealed DBI-BreathCollector is airtight and captures a volume of 1L exhaled breath. The performance of the DBI-BreathCollector was evaluated under different storing conditions. After 144h of storage under 4°C, RT or 37°C the DBI-BreathCollector ensures a qualitative recovery of 50-70% of core exhaled breath VOC's.

#### Notes



Do not use after expiry date.

## 6 Appendix

### 6.1 Breath injection instructions for SESI-HRMS

1. Prepare SESI-HRMS for sample injection: Attach a connection tube (with or without valve) to the SESI inlet allowing to connect the adapter later.
2. Start the measurement at the MS computer using the settings for positive polarity.
3. Inject approx. half of the breath specimen sample from the bag into the analytical device by pressing on the bag with both hands.
4. Stop the measurement.
5. Change the polarity settings.
6. Start the measurement at the MS computer using the settings for negative polarity.
7. Inject the remaining 50% of the sample into the device by folding the bag into half and pressing on the folded bag with both hands.
8. Stop the measurement.
9. Disconnect the empty device.

6.2 Quick Guide - Instructions for Use



**DBI-BreathCollector**

Offline breath collection device



Breath sampling

Instructions

- 1 Label the bag with all relevant information (patient identification, date and time; see reverse). 
- 2 Open the sealing cap wearing gloves (twist, then pull out straight). 
- 3 Unwrap the mouthpiece and plug it into the bag. 
- 4 Take a deep breath and exhale into the mouthpiece until the bag is filled. Take several breaths, if needed. 
- 5 Remove the mouthpiece. 
- 6 Close the bag with the sealing cap (push, then turn to snap). 
- 7 Label the bag with the recipient information and send it to the analytics laboratory. 

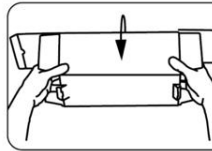
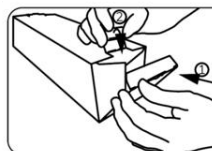
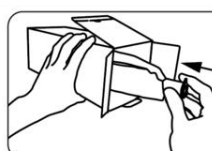

Prepare for shipping

Instructions

- 1 Grab inside the box, slide and lift the walls to create a box. 
- 2 Close the box by folding one sidewall. 
- 3 Turn the box and place the full DBI-BreathCollector into the box. 
- 4 Close the box. The DBI-BreathCollector is ready for shipment. 

Breath injection

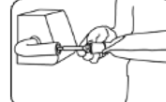
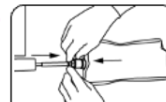
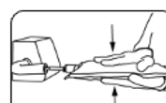
Instructions

- 1 Unpack the bag wearing gloves. Check for damages and that analysis within 144h from sampling. 
- 2 Connect appropriate end of adapter to the analysis device and align and gently insert other end of adapter into sealing cap. 
- 3 Gently push using both hands until a tight fit is achieved. 
- 4 Inject sample by gently pressing on bag with both hands. 
- 5 Fold the bag at the 50% mark. 
- 6 Inject the remaining 50% of the sample. 